

Hitachi Double Beam
Spectrophotometer
U-2900/2910

Hitachi High-Technologies



U-2900/2910

HITACHI

Spectrophotometer simpler to use and higher in dependability thanks to mounting of a large-size color LCD.

High resolution satisfying European Pharmacopoeia (spectral bandpass: 1.5nm). Trace-amount measurement in biotechnological field, etc. can be carried out using optional 50, 25 and 5mL micro-volume cells.

- An abundance of optional accessories for various applications have been lined up.
- Function for automatic data storage in a USB memory is incorporated.
- Validation function and self-diagnostic function are standard with this instrument.
- The UV Solutions control program available at option enables the user to control operations from a personal computer.

(The Model U-2910 is a special model for PC control.)

*: Available at option



Model 124



Model 100-50



Model 150-20



Model U-2000



Model U-2001



Model U-2800



U-2900 /2910

Stable optics due to double beam

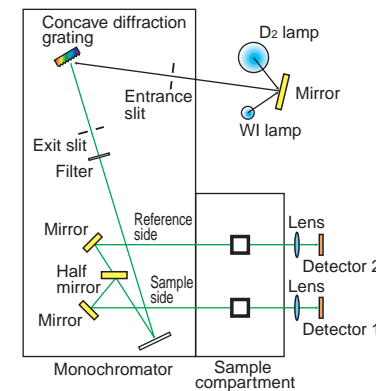

In double beam design, the energy of the light source is divided into two with a half mirror so that one passes through the reference side, and the other through the sample side, which is unavailable with the single beam design.

Since the reference-side energy is also incident on a detector, photometry is carried out on the basis of this signal. Therefore, an energy change in the light source can be compensated to ensure stable measurement for a long time.

Incorporation of stigmatic concave diffraction grating

The optics of this instrument adopts the Seya-Namioka monochromator widespread as a representative concave diffraction grating monochromator.

Because a concave diffraction grating has both beam condensing and dispersing functions, an optical system can be configured with fewer mirrors. In a spectrophotometer, use of fewer mirrors signifies a shorter optical path, thus giving rise to an aberration-free bright optics.

For elimination of the aberrations which were essentially unavoidable in the past, a stigmatic concave diffraction grating has been developed by applying Hitachi's original technology. As a result, a higher resolution has been realized.



A higher resolution has been achieved by eliminating coma from the Seya-Namioka monochromator which is the most popular concave diffraction grating monochromator. Its grooving is supported by the only ruling engine in Japan. The diffraction gratings of Model U-2900/2910 have also been made with this machine.

Spectral bandpass 1.5nm satisfying European Pharmacopoeia

European Pharmacopoeia requires a ratio of 1.5 or larger when measuring 0.02% (V/V) solutions of toluene in hexane. In the spectrum at right, a satisfactory value of 1.6 can be confirmed.

(Sample: 0.02% solution of toluene in n-hexane)

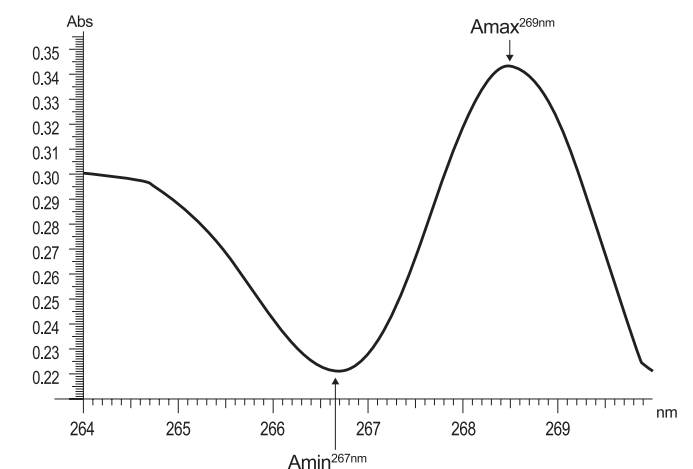

Mounting of 26.4cm color LCD, the largest in this product class



* The size in the photo is 1/2 of the actual LCD size.

Due to a 640 × 480 color LCD with backlight, working curves, spectra and other minute displays are easier to view, and characters are bigger than before, which ensures a high visibility. A dedicated keyboard (for U-2900 alone) is quite helpful for baseline measurement and other operations.



* The photo size is 1/2 of the actual keyboard size.

Introduction of Measurement Modes

Photometry

The concentration of an unknown sample can be determined in comparison with the known concentration of a standard sample.

The linear/quadratic regression curve or polygonal line approximation curve is drawn by measuring plural standard samples (max. 20 samples) to calculate the concentration. In addition, judgment of the upper and lower concentration limits can be set and quantitative analysis can also be carried out via factor input.



Wavelength scan

A spectrum resulting from scanning over a desired wavelength range within 190 to 1,100nm can be displayed. Because each substance has a unique spectrum, its characteristics can be examined.

After measurement, peak search, smoothing and other data processing can be effected. And, a repeat scan capability helps the user trace a chemical reaction process. Baseline correction is also available.



Time scan

A spectrum can be drawn by following a change of photometric value at a single wavelength with the lapse of time. This function is used for analysis of enzymatic reactions. Enzyme activity is measured according to a change of absorbance within the set time period. Peak detection, smoothing, kinetic assay and other data processing can be performed.



Multiple-wavelength measurement

Purity of a nucleic acid can be calculated using a ratio of absorbance values at 2 wavelengths (A260/A280). Furthermore, measurement can be performed while automatically shifting measuring wavelength to a maximum of 6 wavelengths. This is convenient when only measured data at each wavelength is desired.

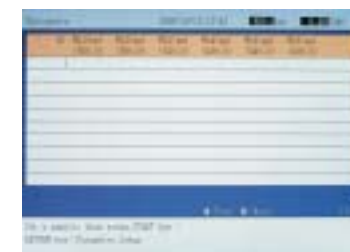

Highly dependable system incorporating automatic calibration and self-diagnostic function.

A highly dependable system was designed by incorporating lots of functions for memory check, wavelength drive check, lamp ignition check, automatic wavelength calibration, lamp ignition time display, etc.

(This function is standard with the Model U-2900 main unit. The Model U-2910 provides the equivalent functions via PC control.)

Validation function

This is a function for checking the performance of Model U-2900/2910 main unit. The following items can be checked.

- Wavelength accuracy
- Wavelength setting repeatability
- Bandpass
- Baseline flatness
- Baseline stability
- Noise level



Example printout 1 of validation function with dot impact printer (for 1 check item)

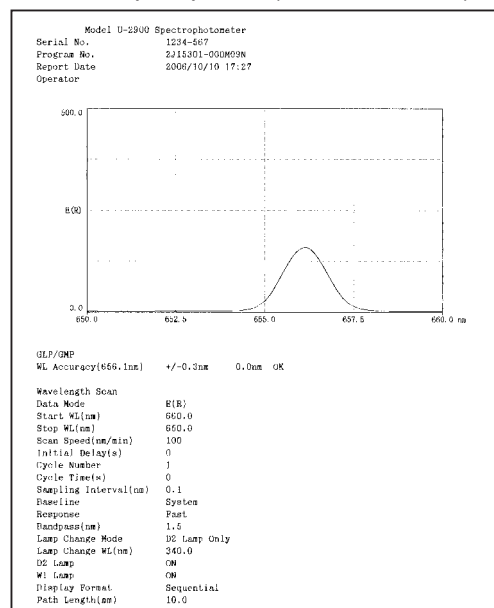

Automatic calibration and self-diagnostic function

Upon initialization, memory check, wavelength drive mechanism check, lamp ignition check and 656.1nm check are automatically diagnosed and adjusted.

Also, the automatic wavelength calibration function is incorporated for automatic calibration by using the bright line of D₂ lamp as a reference wavelength.

Besides, each cumulative ignition time of the W1 and D₂ lamps can be displayed. This function is useful for instrument management.



Example printout 2 of validation function with dot impact printer (covering all check items)

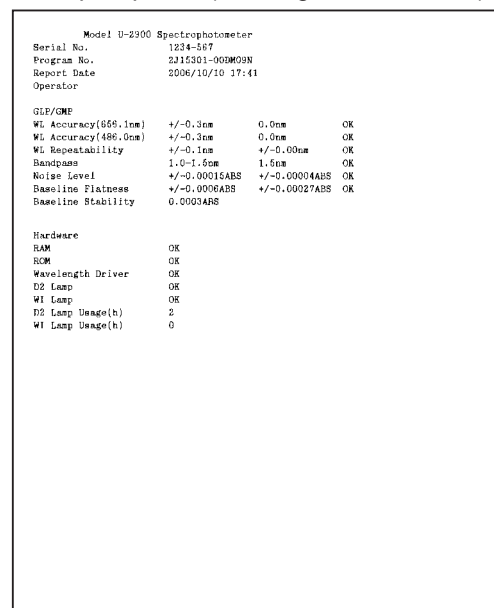

Easy to Save Measured Data.

Measured data can be saved in a commercially available USB flash memory*. The data is savable in the text file format. A commercial spreadsheet program can processing the measured data.

* Not all of the commercial USB flash memory products are usable. Contact us separately.

Data saving with USB flash memory

Data can be transferred easily to PC by means of a USB flash memory.



Data loading

Because the measured data is saved in the text file format, it is sent directly to a commercial spreadsheet program. This function can be utilized for detailed data analysis, report generation, etc.

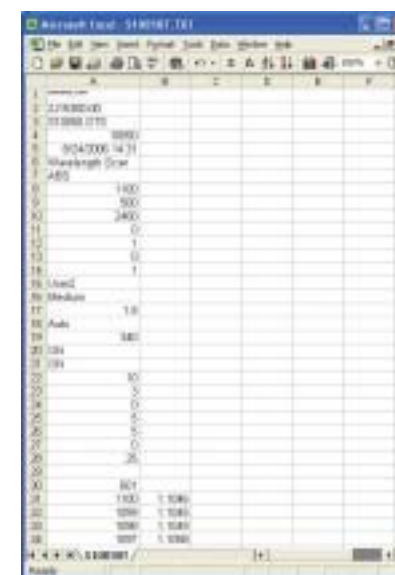

Printout of data from spectrophotometer

The data measured with the spectrophotometer including spectra and working curve graph can be printed with a small-sized thermal printer (DPU) separately available.



* Contact us separately.

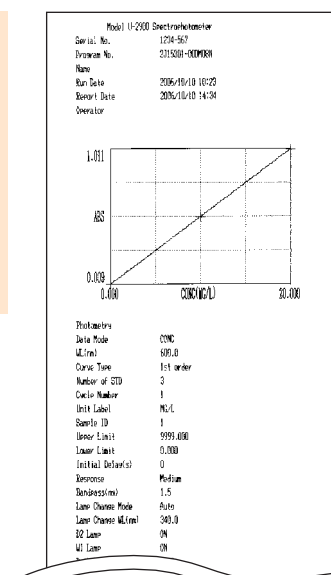

Personal computer-based instrument control and data processing.

The Model U-2900 becomes controllable from PC when the UV Solutions program (P/N 2J1-0310) is installed. Not only the U-2900 functions such as photometry and wavelength scan, but also data pasting to another application program, data transfer, report generation, etc. will be supported.

(The Model U-2910 is a special instrument for PC control.

A PC compatible with Windows® XP needs to be prepared separately.)



Instrument application further expandable by UV Solutions program.



U-2910 is a special model for PC control.

Simple to use

Buttons are laid out so as to follow the operating procedure. Hence, operations can be performed smoothly.

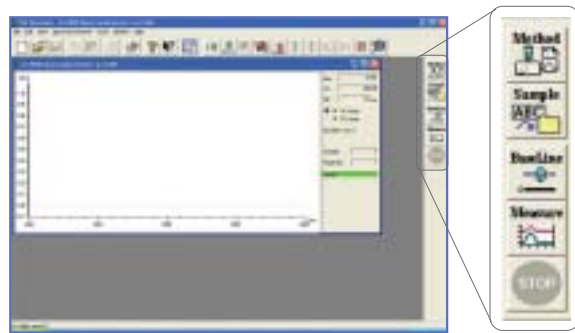

A rich variety of data processing functions

Spectrum can be expanded, contracted, smoothed, differentiated and integrated, and fundamental arithmetic calculations are applicable between spectra.

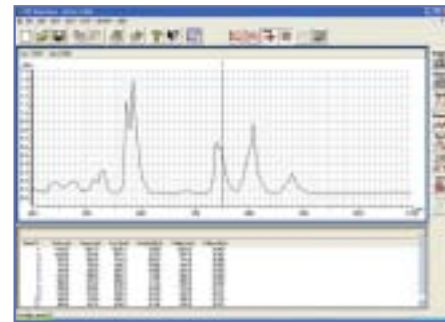

Powerful support for report generation

Measured data can be sent to Microsoft® Excel. One click of the Report button suffices for data transmission.



A spectrum can be pasted to another application program.

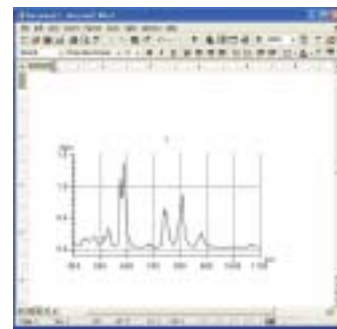

Print preview

Before printing, the contents can be checked by the Print Preview command.

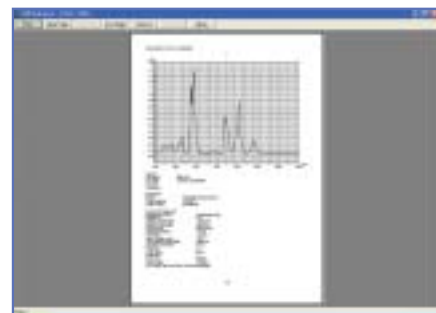

Measured data text convertible

Besides conversion into the ASCII text or J-CAMP format, spectra can be saved in Metafile format.



Windows® XP and Microsoft® Excel are trademarks of Microsoft Corporation, U.S.A. Microsoft® and Windows® are registered trademarks of U.S. Microsoft Corporation in USA and other countries.

Option package program (P/N 2J1-0311)

Capable of performing color calculation and color difference calculation.

Nucleic acid measurement program (P/N 2J1-0316)

Usable for checking extraction and refinement of nucleic acids such as DNA/RNA essential for genetic research. Data (photometric values at 230, 260 and 280nm), and calculation results (260/280, nucleic acid concentration, protein concentration, molar concentration) can be displayed collectively on the screen.

GLP/GMP program (P/N 2J1-0317)

The burden of optical instrument performance check can be alleviated. Item-dependent measurement mode and automatic measurement mode (when no sample is necessary) have also been prepared. In addition, a judgment tolerance range is settable so as to meet each analytical purpose.

Report generator program (P/N 2J1-0312)

Developed to enable freely customizing the report output format of measurement results. Each character size and position of report items and comment are settable and besides, mathematical calculations conventionally dependent on manual method can be executed by spreadsheet program functions.



UV Navigation program (P/N 2J1-0313)

Provides support for automation of measurement, data processing and printout. Measuring procedure can be readily programmed using a graphical editor for implementation of spectrophotometer control, measurement result indication and judgment, etc. Because analytical procedure can be automated, it is possible to save labor and form working patterns. This is effective for routine work such as quality control.



Diverse optional accessories selectable for specific applications such as multiple samples and trace sample.

Auto sipper

(P/N 2J1-0100)

This computer-controlled sample sipper is provided with a sample recovery function and other versatile functions. In combination with an autosampler, this unit will further advance automation and labor saving in the preparatory stage. This sipper cannot control temperature.



Specifications

Minimum sample volume	0.6mL
Carryover	1% or less
Cell capacity	About 50µL
Optical path length	10mm
Reference beam side	10mm rectangular cell mountable

Auto sipper with temperature control

(P/N 2J1-0101)

Designed to have the same structure as the above auto sipper. Because the flow cell section can be maintained at a constant temperature, exact control is ensured.



Specifications (without temperature control on reference side)

Minimum sample volume	0.6mL
Carryover	1% or less
Cell capacity	About 50µL
Optical path length	10mm
Settable temperature	20 to 40°C
Reference beam side	10mm rectangular cell mountable

AS-1010 Auto sampler

(P/N 2J1-0121/0122)

In combination with the auto sipper or in flow injection analysis, this unit is used for multiple-sample measurement. A suction needle can be moved in three directions X, Y and Z.

Specifications (sample tube not included)

Sample tube size	Outer diameter 15mm, height 105mm (option required)
	Outer diameter 12 mm, height 105 mm

6-cell positioner with temperature control

(P/N 2J1-0103/0104)

Six 10mm cells can be mounted on the sample beam side, and they can be changed over automatically at certain intervals.



Specifications

Difference in capacity due to cell changeover	Within ±0.5% (at 100%T)
Applicable cell	10mm cell (not included in this product)
Settable temperature	20 to 40°C

Electronic thermostatted cell holder

(P/N 131-0306/0307)

Standard-equipped with a magnet stirrer to maintain a constant sample temperature in each cell. Temperature can be indicated down to a minimum 0.01°C scale. Because of an electronic thermostatted type using forced air cooling, this cell holder is capable of quick heating and cooling. A thermostatic chamber is unnecessary. (Temperature control: S only)



Specifications

Control temperature range	10° to 60°C (settable in steps of 0.01°C (normal temperature 25°C))
Temperature setting accuracy	Within ±2°C* (difference between set temperature and sample temperature)
Temperature stability	Within ±0.5°C*

* Room temperature: 25°C, sample: distilled water

Electronic thermostatted cell holder

(Thermostatted water bath is needed separately)(P/N 131-0301/0302)

In the measurement of protein or nucleic acid fusion, a sample temperature can be changed continuously to determine variation in absorbance. Being of an electronic thermostatted type, this cell holder is capable of quick heating and cooling. Sample temperature can be increased and decreased isothermally. In addition, the set temperature can be maintained evenly inside a cell, because a stirrer is provided. (Temperature control: S and R)



Specifications

Control temperature range	0° to 100°C (settable in steps of 0.1°C (normal temperature 25°C))
Temperature setting accuracy	Within ±2°C* (difference between set temperature and sample temperature)
Temperature stability	Within ±0.5°C*
Equipped with isothermal temperature regulation function	

* Room temperature: 25°C, sample: distilled water, circulatory water temperature: 22°C, set temperature: 10 to 60°C
A circulating thermostatic chamber needs to be prepared separately.

Water circulated cell holder

(P/N 210-2111)

Water from a thermostatic chamber is circulated through this cell holder to maintain a sample cell at a constant temperature.



Specifications

(circulating thermostatic chamber and cell not included in this product)

Operating temperature range	From normal temperature to 40°C
Temperature stability	Within ±0.3°C

Micro flow cell unit

(P/N 210-2113)

Suitable for continuous measurement of a trace sample.



Specifications

Cell capacity	70µL
Optical path length	10mm (quartz flow cell used)
Withstand pressure	Max. 0.1MPa
Connecting tube	Teflon tube. Outer diameter 2mm, inner diameter 1mm

Flow cell unit

(P/N 210-2173)

The inside of this cell is structured to minimize stagnation of liquid and adhesion of air bubbles.



Specifications

Cell capacity	600µL
Optical path length	5mm (quartz flow cell used)
Withstand pressure	Max. 0.1MPa
Connecting tube	Teflon tube. Outer diameter 4mm, inner diameter 3mm
Reference beam side	5mm rectangular cell (standard accessory)

LC flow cell unit

(P/N 210-2131)

Exclusively used for a liquid chromatograph. In wavelength scan, the baseline is always kept flat.



Specifications

Cell capacity	8µL
Optical path length	8mm (quartz flow cell used)
Baseline flatness	±0.001Abs (200 to 350nm) ±0.002Abs (190 to 850nm)

Micro cell holder

(P/N 122-0060)

Suitable for measurement of trace samples in medical and biochemical fields.

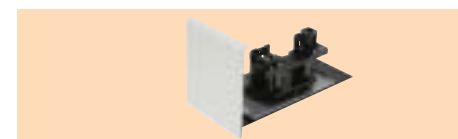

Specifications (cell required separately)

Wavelength range	220 to 950nm
Cell mounting /dismounting repeatability	Within ±0.3%T
Baseline flatness	Within ±0.005Abs (50mL micro-volume cell used)

Tandem cell holder

(P/N 210-2115)

Up to three 10mm cells can be mounted on each of the sample and reference beam sides. Sample temperature can be maintained at a constant level by circulating constant-temperature water through the cell holder section.



Specifications (circulating thermostatic chamber and cell not included in this product)

Control temperature range	15 to 40°C
Temperature stability	±0.3°C

Rectangular long path cell holder

(P/N 210-2107)



Conditions of applicable rectangular cell are given below.

Optical path length	10, 20, 30, 40, 50, 100mm
Outer width	12.75mm

5-Position turretcell holder

(P/N 210-2110)

Five 10mm rectangular cells can be mounted on the sample beam side and a micro cell mask (P/N 200-1537) can be inserted in each cell holder. (Cell and micro cell mask are not included in this product.) It is recommended to prepare a set of five cells.



Recommended cell sets

124-0352	10mm quartz cell set (5 cells in set)
124-0378	10mm glass cell set (5 cells in set)

4-Position rectangular long path cell holder

(P/N 150-0940)

Four rectangular long path absorption cells can be mounted on the sample beam side and they can be changed over externally.



Specification

Cell length	100mm, 50mm to 10mm cells applicable
-------------	--------------------------------------

Glass filter holder

(P/N 210-2109)

Used for transmittance/absorbance measurement of such a solid sheet sample as glass filter.



Specifications

Sample thickness	0.5 to 5mm
Sample size	12 × 25mm to 55 × 100mm

Cylindrical long path cell holder

(P/N 210-2108)

Used for measurement with a cylindrical cell.



Film holder

(P/N 210-2112)

Designed for measurement of film-like samples.



Specifications

Film frame	Width 25mm, height 30 to 50mm
Beam aperture	Width 10mm × height 20mm

Polarizer holder

(P/N 210-2130)

Used for linearly polarizing the sample beam to check its polarization characteristic and for measuring optical rotary power with a sample placed between the polarizer and analyzer.



Specifications

Wavelength range	400 to 750nm
Sample thickness	0.5 to 5mm
Sample size	Min. 12 × 25mm/max. 55 × 100mm

Mask for Micro cell

To be inserted into a standard rectangular cell holder for measurement of a trace sample.

Specifications

200-1537	Mask for Micro cell (1.5mm)
200-1538	Mask for Micro cell (1.2mm)

Cell

124-0357	Micro quartz cell, 10mm
200-0551	Black quartz micro cell, 10mm

The following cells are usable for the above micro cell holder (P/N 122-0060).

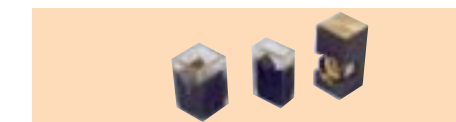

Part No.	Part name	Capacity	Optical path length
130-0622	50 micro cell	50µL	10mm
130-0623	25 micro cell	25µL	5mm
130-0621	5 micro cell	5µL	0.5mm

Examined 10mm rectangular quartz cell

(P/N 210-1462)

Optical path lengths measured at 21 points on cell using a three-dimensional measuring instrument are indicated down to the fourth decimal place (mm).

Communication cable

(P/N 121-1521)

A computer and the spectrophotometer main unit need to be connected with this cable for computer control of measurement using the UV Solutions program.

U-2900/2910

Specifications

Optical system	Double beam
Wavelength range	190 to 1,100nm
Spectral bandpass	1.5nm
Stray light	0.05% or less (220nm for NaI, 340nm for NaNO ₂)
Wavelength accuracy	±0.3nm (at 656.1, 486.0nm)
Wavelength setting repeatability	±0.1nm
Photometric range	-3 to 3Abs
	0 to 300%T
Photometric accuracy (certified according to NIST SRM 930)	±0.002Abs (0 to 0.5 Abs)
	±0.004Abs (0.5 to 1.0Abs)
	±0.008Abs (1.0 to 2.0Abs)
	±0.3%T
Photometric repeatability (certified according to NIST SRM 930)	±0.001Abs (0 to 0.5Abs)
	±0.002Abs (0.5 to 1.0Abs)
	±0.004Abs (1.0 to 2.0Abs)
	±0.1%T
Wavelength scan speed	10, 100, 200, 400, 800, 1,200, 2,400, 3,600nm/min
Response	Fast, standard, slow
Baseline stability	0.0003Abs/h (at 500nm, 2 hours after power-on)
Noise level	±0.00015Abs (at 500nm)
Baseline flatness	±0.0006Abs (within 200 to 950nm)
Light source	WI and D ₂ lamps
Light source changeover	Auto (user selectable from 325 to 370nm)
Detector	Silicon photodiode
Display	U-2900: color LCD with backlight (26.4cm)
Printer I/F	U-2900: Centronics interface
Serial I/F	RS-232C (exclusive for UV Solutions program)
Size (main unit)	U-2900: 500 (W) × 605 (D) × 283 (H)mm (with LCD lowered)
	U-2910: 500 (W) × 605 (D) × 241 (H)mm (without PC and printer)
Weight (main unit)	U-2900: 31kg, U-2910: 29kg
Power supply	100, 115, 220, 230 or 240 V, 50/60Hz
Power consumption	300VA

Software functions

- Measurement mode
 - Photometry
 - Wavelength scan
 - Time scan
 - Multiple-wavelength
- Ratio (260/280)
- Working curve type
 - Linear
 - Quadratic
 - Polygonal line
 - K factor input
- Calculation of correlation coefficient
- Concentration unit input
- Kinetic assay
- Spectrum and working curve printout
- Spectrum display
- Peak/valley detection
- Tracing
- Scale expansion/contraction
- Smoothing
- Differentiation
- Area calculation
- Fundamental arithmetic calculations between spectra
- Data saving
- Validation function
- Automatic wavelength calibration
- Lamp ignition time

* These are functions of Model U-2900 main unit. Equivalent functions are provided under PC control.

NOTICE: For proper operation, follow the instruction manual when using the instrument.

Specifications in this catalog are subject to change with/or without notice, as Hitachi High-Technologies Corporation continues to develop the latest technologies and products for our customers.

Hitachi High-Technologies Corporation

Tokyo, Japan

<http://www.hitachi-hitec.com/science/>

24-14 Nishi-Shimbashi 1-chome, Minato-ku, Tokyo, 105-8717, Japan

Tel: +81-3-3504-7211 Fax: +81-3-3504-7302

Contact us

Hong Kong
Techcomp Limited
Tel: +852-2751 9488
Web: www.techcomp.com.hk

Singapore
Techcomp Singapore Pte Ltd
Tel: +65-62678921
Web: www.techcomp.com.sg

Thailand
Techcomp Thailand
Tel: +66-2-576 1629-30
Web: www.techcomp.co.th



Printed with soy ink on 100% recycled paper.